

THE DEVELOPMENT OF IMPLANTABLE MEDICAL DEVICES AT THE APPLIED PHYSICS LABORATORY

For the last twenty years, the Applied Physics Laboratory has been actively engaged in the development of implantable medical devices, the design of which is based on the transfer of space technology. The first device was the Johns Hopkins Rechargeable Cardiac Pacemaker. After being implanted for eighteen years, hundreds of these devices are still functioning in patients throughout the United States. The most recent device is the Programmable Implantable Medication System, which is currently being used as the most advanced treatment for diabetic patients.

In the next twenty years and for decades beyond, this innovative technology will be applied to many thousands of patients who can benefit from these implantable medical devices.

THE RECHARGEABLE PACEMAKER

In 1967, in an issue of the IEEE magazine *SPECTRUM*, an advertisement by the Mallory Battery Company showed an X-ray picture of a man with a cardiac pacemaker implanted in his upper chest. The advertisement stated that Mallory batteries were so good that they could last as long as two years when implanted in a human subject. But what happened to this patient when the batteries were depleted? Did he die? More probably, new batteries were put in or, possibly, a new pacemaker was implanted. But what if one used long-lived, rechargeable Ni-Cd cells of the type developed for spacecraft use, and recharged them by magnetic induction through the skin? Could a smaller and lighter pacemaker be fabricated that might last as long as ten years? I cut out the advertisement and planned to go back to it someday.

The rechargeable pacemaker project was started as a result of the active intervention of Frank T. McClure, then head of APL's Milton S. Eisenhower Research Center. Those APLers who were fortunate enough to work with Dr. McClure knew him to be a brilliant, innovative leader of scientific teams. In the late 1960s, Dr. McClure and Joseph Massey advanced the idea that we should apply the high technology know-how of APL to solve unique medical problems by forming a collaborative program with the Johns Hopkins School of Medicine. A good way to start would be to invite cardiologists from the Johns Hopkins School of Medicine to present important, unresolved problems to a select group of APL staff members, followed by a second meeting several months later when (in this simplistic format) the APLers would present suggested solutions to at least some of the problems.

At that first session, not one of the cardiologists stated that they would like to see an improved cardiac pacemaker. At lunch on the second day, however, Dr. Kenneth B. Lewis, Assistant Professor of Medicine at the Johns Hopkins School of Medicine, mentioned that he was a pacemaker planter. He was asked the critical question,

“What do you do when the battery is discharged?” His answer: Most patients require surgical replacement, but some die. Dr. Lewis further stated that, in fact, pacemakers have a mean time to failure of less than eighteen months. Later data¹ indicated that pacemakers typically failed after approximately twelve months (Fig. 1). When asked if a pacemaker that would last at least ten years would be a significant accomplishment worthy of a collaborative program between APL and the Johns Hopkins School of Medicine, Dr. Lewis replied in the affirmative.

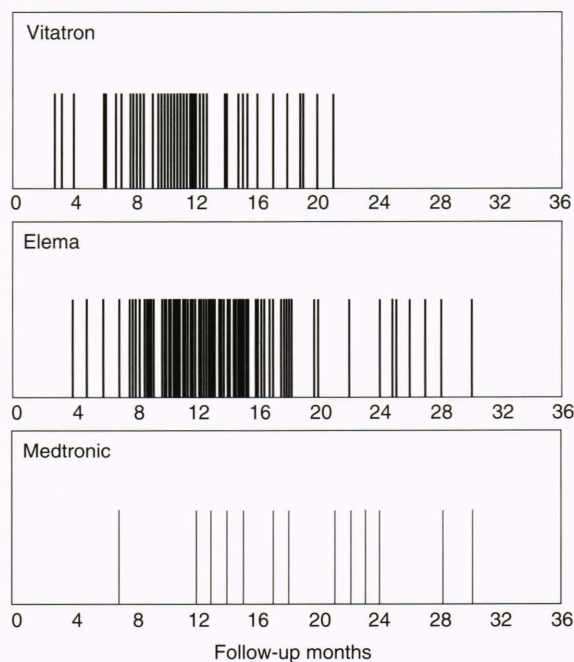

Figure 1. The distribution of pacemaker failures in time for 200 pacemaker implants. Each vertical bar represents the time at which one of the pacemakers failed.

At that point, several staff members at APL decided to attempt to build a working model of a rechargeable pacemaker for evaluation by Dr. Lewis.

Wade Radford (who worked on Ni-Cd batteries for satellites) found an appropriate Ni-Cd cell, and Arthur Hogrefe devised a circuit that could charge the cell by magnetic induction through the skin. George Seylar devised an efficient 72-pulse-per-minute heart tissue pulsing circuit to provide the required 1.0-ms-width pulses at approximately 5 V into a 500-ohm load. The resulting circuitry is shown in Figure 2.²

As a result of the skilled efforts of Radford, Hogrefe, and Seylar, one week after Dr. Lewis' visit to APL the working pacemaker circuit was shown to Dr. Lewis for his comments. He agreed that this was truly a major breakthrough worth carrying through to a fully implantable device. And so began a program from which have evolved all the implantable clinical devices that found future applications in the treatment of thousands of patients.

Getting the R&D Started

Having reached the conclusion that the application of the rechargeable Ni-Cd cell could make a better pacemaker, a first problem was to obtain space-qualified, cylindrically shaped Ni-Cd cells that had the desired capacity of 0.2 A·h, approximately 1.0 in. in diameter, and less than 0.5 in. high. The Sonotone Corporation, which provided hermetically sealed Ni-Cd cells to APL for the first Transit satellites, offered to make twenty such small, space-qualified cells for \$11,000. With the invaluable assistance of Dr. Lewis, a grant of \$11,000 was obtained from Baltimore City to fund the work. Everything was falling into place for the development of a rechargeable pacemaker.

But when the \$11,000 check made out to APL was received, there was considerable consternation as to how this money could be accepted under the Navy contract. At this point, Ralph E. Gibson, APL's Director, interceded and found a way to accept this money so that the rechargeable pacemaker project could begin.

Finding a Commercial Sponsor

It did not take long to realize that, although APL might be capable of building a few pacemakers, we could not and would not make the thousands of units that would be needed if we were to succeed. A discussion of the problem with Alfred E. Mann, President of Spectrolab, Inc., in early 1968 resulted in a solution. Spectrolab supplied most of the solar cells for APL and other U.S. satellites. On the day that Al Mann was asked to be the pacemaker's commercial sponsor, Spectrolab had just lost a major government contract to provide the largest solar array ever conceived, which would be used on the manned laboratory in space aptly named Spacelab. Because Al Mann was disappointed about losing that major contract, he was excited about the idea of getting away from government-sponsored projects. He then agreed to personally back the rechargeable pacemaker project, and he did just that.

Concept and Early Development

It soon became apparent that, even though a pacemaker power source could be made to last ten or more years, the system's reliability depended on other factors, specifically, the electronic components. All other pacemakers were potted in plastic through which body fluids could penetrate after a few years in the human body. Thus began the design of what was later called the Johns Hopkins Rechargeable Pacemaker, which was the first to be hermetically sealed to eliminate electronic component degradation by exposure to body fluids. Further, all the reliability and quality assurance techniques then used on APL spacecraft (but never before applied to circa 1968 pacemakers) were used in component selection and testing for the rechargeable pacemaker. Furthermore, the concept of using telemetry to indicate pacemaker performance and predict potential failure was first used with the rechargeable pacemaker. Specifically, as seen in Figure 3, the pacemaker's pulsing rate was used to measure the critical Ni-Cd battery voltage so that there would always be an accurate indication that the Ni-Cd cell was being properly charged.

Figure 2. Circuit diagram for rechargeable fixed-rate pacemaker as first made at APL to demonstrate the concept of a rechargeable pacemaker. FET = field effect transistor.

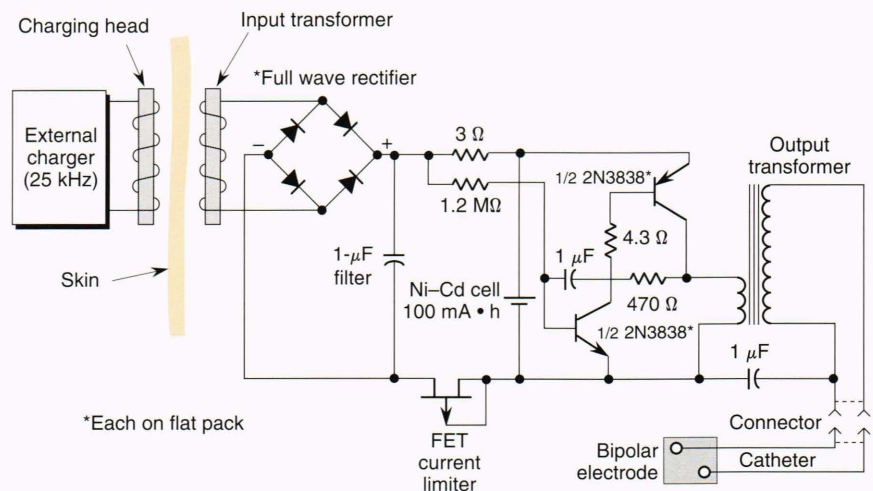

But no advance in medical devices was ever achieved easily. The Sonotone batteries never worked properly, and it took hundreds of thousands of dollars for the General Electric Company, Battery Division, to make a truly reliable, human-rated Ni-Cd cell. Getting an alternating magnetic field at 25 kHz to penetrate a titanium metal hermetic enclosure was another problem. But after six years of multiple failures and a few hard-won successes including several years of proper operation in laboratory dogs (see Fig. 4), the rechargeable pacemaker was finally ready for implantation in a human subject. Figure 5 shows the first Johns Hopkins Rechargeable Pacemaker manufactured by Pacesetter Systems, Inc., a company founded by Al Mann for the sole purpose of making the rechargeable pacemaker.

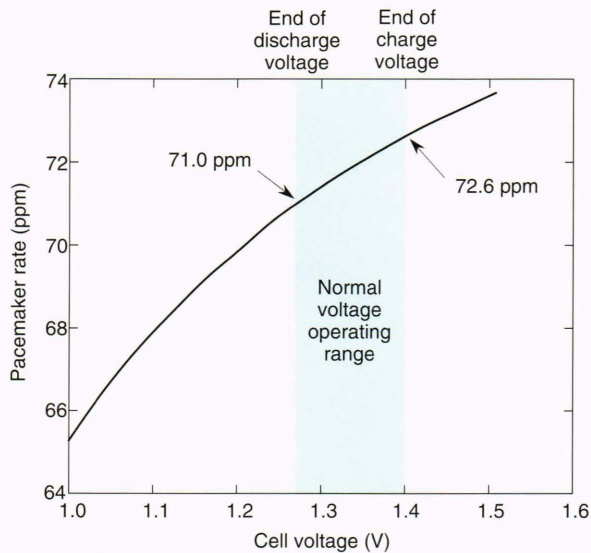

Figure 3. Telemetry of battery voltage by means of pulse rate for the first human implant model of the rechargeable pacemaker.

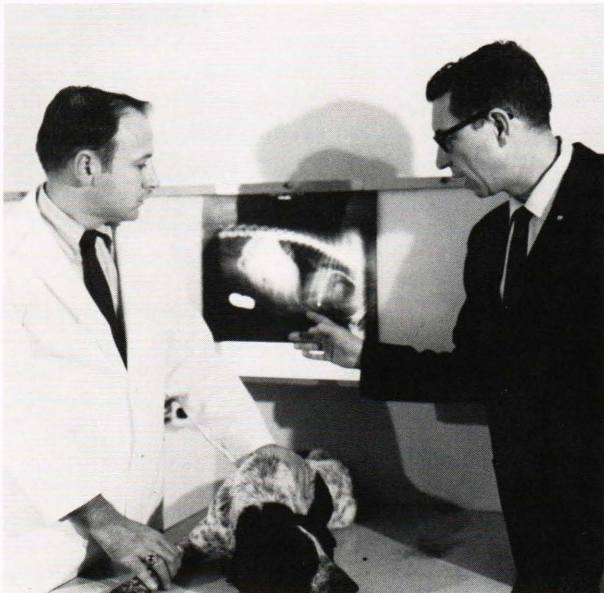

Figure 4. Dr. Lewis and the author discussing the location of the pacemaker and stimulating electrodes that were regulating the heartbeat of a laboratory dog.

The First Implant

The first implant took place on 10 February 1973. Helen Chambers, age 76, was prepared for the procedure in one of the operating rooms at The Johns Hopkins Hospital. With just a local anesthetic, the surgeon, assisted by Dr. Lewis, easily implanted the device in a pocket in the patient's upper chest. When the procedure was completed, there was a bulge in Mrs. Chambers skin dramatically smaller than for any other pacemaker that was available at that time. Thirty minutes after the procedure started it was all over, and the patient was returned to her hospital room. The next critical moment came in that room when Dr. Lewis placed the charging head over the implanted device. Dr. Lewis and the APL participants were delighted and relieved when the telemetry signal indicated normal charging of the implanted Ni-Cd cell.

One week later, Dr. Lewis and I went to Mrs. Chambers' home for her first weekly recharging. Figure 6 clearly shows our satisfaction with the outcome of that procedure.

Pacemaker Epilogue

Looking back after nearly twenty years since the start of the project, one can reflect on what impact it had. The following is a summary of the results with the pacemaker as of May 1991.

First human implant	10 Feb 1973
Last human implant	1984
Oldest patient at implant	93
Youngest patient at implant	One week
Total number implanted	(approx.) 5920
Number of units surviving	1606
Average pacemaker lifetime	8 years
Longest pacemaker lifetime	17.8 years

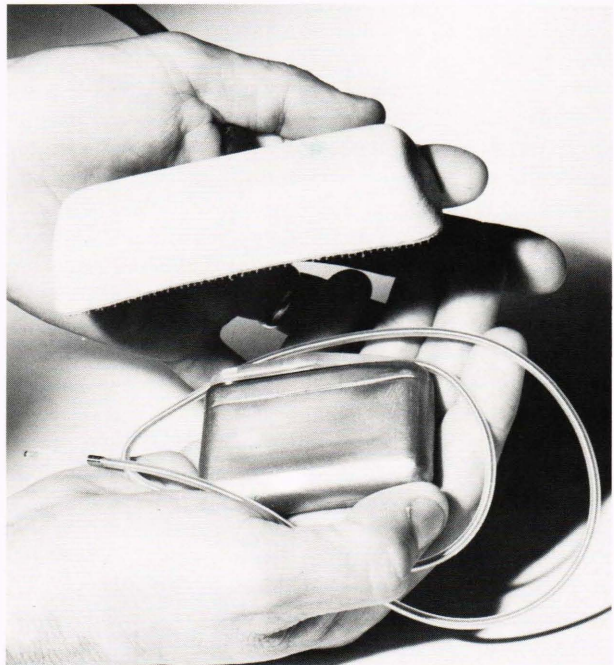

Figure 5. The Johns Hopkins Rechargeable Pacemaker shown in close proximity to the charging head.



Figure 6. The author and Dr. Lewis with the first recipient of the Johns Hopkins Rechargeable Pacemaker, Mrs. Helen Chambers.

The impact of the pacemaker can be summarized as follows:

1. Pacesetter Systems, Inc., manufactured over 6000 of the Johns Hopkins Rechargeable Pacemakers.
2. Hermetically sealed pacemakers are now the only type used.
3. All current pacemakers have telemetry systems for informing the physician how the device is performing.
4. Space reliability and quality control techniques are used for all pacemaker components, which results in a dramatic improvement in longevity.
5. By applying the techniques described above, Pacesetter Systems, Inc., has become the second largest pacemaker company in the world.
6. As part of the arrangement for licensing the rechargeable pacemaker patents, APL (via the A. E. Mann Fund) has received over \$2 million dollars to support future medical device development.

What has happened to the rechargeable pacemaker? It is no longer manufactured, because a lithium-iodide cell was invented that was as small as the rechargeable cell and lasted an acceptably long five years without requiring the battery recharging equipment. The story should not be concluded on such a negative note, however. Figure 7 shows the status of the implants as of May 1991. Most of the 5920 pacemakers are not implanted today not because of failure, but because the average pacemaker patient has a six-year life expectancy.

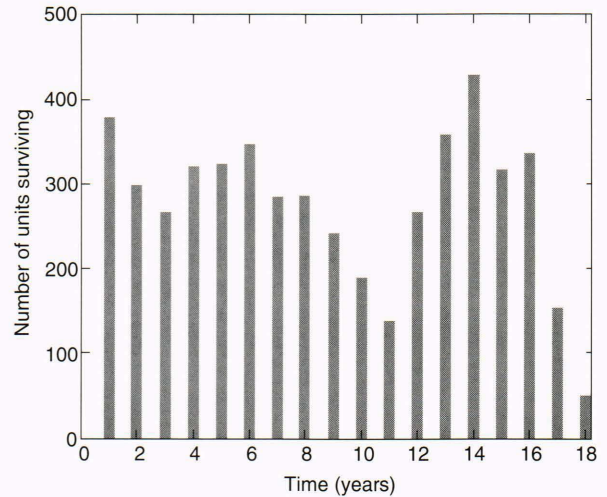

Figure 7. Lifetimes for the Johns Hopkins Rechargeable Pacemaker.



Figure 8. A three-year-old with a pacemaker implanted in the abdomen doing her own recharging.

The number of pacemakers still functioning after fifteen years is remarkable when one considers that they lasted only one year on average when the program was begun in 1968. Fortunately, many devices were implanted in young children, such as three-year-old Jennifer (Fig. 8). At NASA's request, Jennifer and her parents testified before a congressional committee on this achievement of space technology transfer. When Jennifer's mother testified (with tears in her eyes) that her daughter could now run and play like any normal child her age, funding for other technology transfer programs was assured.

THE HUMAN TISSUE STIMULATOR

At the time the rechargeable pacemaker was in regular human use, Dr. Irving S. Cooper in New York City published an article on electrical stimulation to treat epilepsy. Electrical stimulation was also being used to treat such diverse human disorders as cerebral palsy, multiple sclerosis, and intractable pain. All these applications required much higher levels of electrical power than did a cardiac pacemaker. It was logical then to build a bigger Ni–Cd cell (to be exact, 1.0 A·h) and apply it to create a rechargeable Human Tissue Stimulator (HTS) for a variety of applications.

Because this was another application of space technology, a proposal was submitted to the NASA group responsible for the transfer of space technology into the public domain. With the support of Donald Friedman, who headed the development of such programs at the Goddard Space Flight Center, APL received funding to develop the HTS device.

A simplified block diagram of the HTS is shown in Figure 9. Hermetic sealing, rechargeability through the intact skin, and a telemetry system had already been accomplished with the rechargeable pacemaker. The HTS, however, had a vastly more sophisticated telemetry system and, for the first time in an implanted device, an elegant set of commandable parameters that could utilize an external radio signal to alter the device's operating mode. Table 1³ lists the nine different commandable parameters that were used in the HTS.

On 7 March 1981, the first HTS was implanted at The Johns Hopkins Hospital in a 34-year-old Baltimore man who had nerve damage and chronic pain as a result of a severe wrist injury. By stimulating nerves in the neck that connect the wrist to the brain (see Fig. 10), the HTS successfully eliminated that pain, which was not treatable by any other therapy.

Figure 11 shows Dr. Donlin M. Long, Chief of Neurological Surgery at the Johns Hopkins School of Medicine, with that first patient who is placing the charging head over the HTS. As can be seen on the screen of the patient programmer, the parameter that has been called up to be optimized for the patient's pain relief is "Width

Table 1. Commandable parameters for cerebellar stimulation.

No.	Parameter	Range	Resolution/step (increasing)	No. of values	Program method
1	Amplitude	0–12.8 V	0.1 V	128	Ramping
2	Pulse rate	1–241 pps	3% to 6%	128	Ramping
3	Pulse width	0.061 s–0.97 ms	0.061 ms	16	Direct
4	Pulse group on time	0.016 s–8.53 min	100%	16	Direct
5	Pulse group off time	0.25 s–2.28 h	100%	16	Direct
6	Mode select	8 modes	—	8	Direct
7	Patient on-off	On-off	—	2	Direct
8	Jam on-normal	Jam on-or normal	—	2	Direct
9	Readout state	Value for each parameter	—	8	Direct

Selection," that is, the pulse width of the electrical stimulation signal.

An additional HTS device was implanted by Dr. Cooper's group in a Valhalla, New York, woman who suffered from an involuntary motion disorder. Before HTS implantation, the patient's hand shook so severely that she could not hold a glass to her mouth in order to drink. After HTS was implanted with electrodes placed on the surface of the patient's cerebellum, nearly all the uncontrolled motion disappeared, and her daily activities were no longer significantly limited.

What happened to these patients? The pain patient continued to use the HTS system for more than six years, at which time a battery charge control sensor failed. By then, a new, short-lived device manufactured by Medtronic, Inc., was implanted in the patient to continue his pain relief. The latest development is that Medtronic now realizes that rechargeable tissue stimulators are highly advantageous. The Laboratory is currently working with Medtronic to carry on the rechargeable HTS technology for future applications.

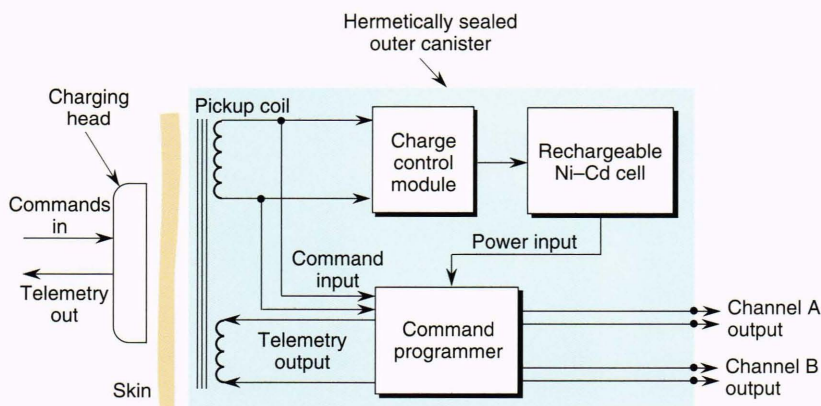

Figure 9. Diagram of the fully implantable Human Tissue Stimulator.

THE AUTOMATIC IMPLANTABLE CARDIAC DEFIBRILLATOR

Dr. Mirowski's Invention

Shortly after the rechargeable pacemaker development work began at APL, Dr. Michel Mirowski, a cardiologist at the Johns Hopkins School of Medicine and the Sinai Hospital of Baltimore, conceived the Automatic Implantable Cardiac Defibrillator (AICD). The AICD is implanted just under the skin in the upper abdominal area of patients at risk for ventricular fibrillation, which is a rapid, uncoordinated contraction of heart fibers brought on by a

severe disturbance of cardiac electrical activity. The shape of the AICD is similar to that of commonly used heart pacemakers, but its function is markedly different.

About the size of a cigarette package, the implanted defibrillator is programmed to monitor the heart continuously, recognize life-threatening arrhythmias, and automatically deliver electric shocks through electrodes directly in contact with the heart to restore the normal rhythm.

The highly miniaturized version of the bulky conventional defibrillator does essentially what doctors do in emergency rooms when they apply a powerful external shock to a patient suffering from this form of heart attack.

Because it is implanted, the defibrillator uses only a fraction of the voltage needed externally to accomplish the same thing. Most importantly, the implanted defibrillator automatically makes the diagnosis and implements the appropriate therapeutic decision. Thus, its unique advantage is its permanent availability to the patient without requiring the presence of special personnel or bulky equipment.⁴

Figure 12 shows the AICD device with the long, slender lead that goes into the patient's superior vena cava and a cup electrode. Figure 13 shows the cup electrode just under the heart, the long, slender lead in the superior vena cava, and the AICD pulse generator under the skin in the patient's chest.

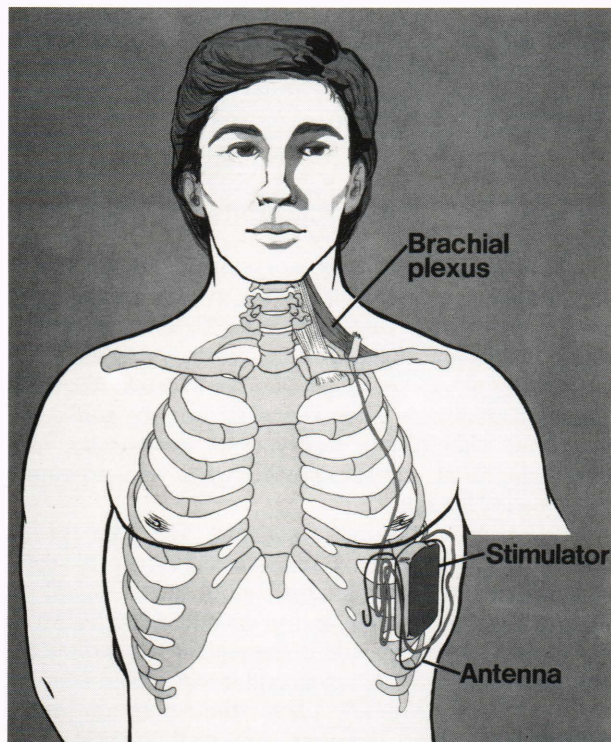

Figure 10. The Human Tissue Stimulator implanted under the skin in the chest with electrodes stimulating the brachial plexus nerves.



Figure 11. Dr. Donlin M. Long (right) adjusting the electrical stimulation parameters for the first Human Tissue Stimulator patient.

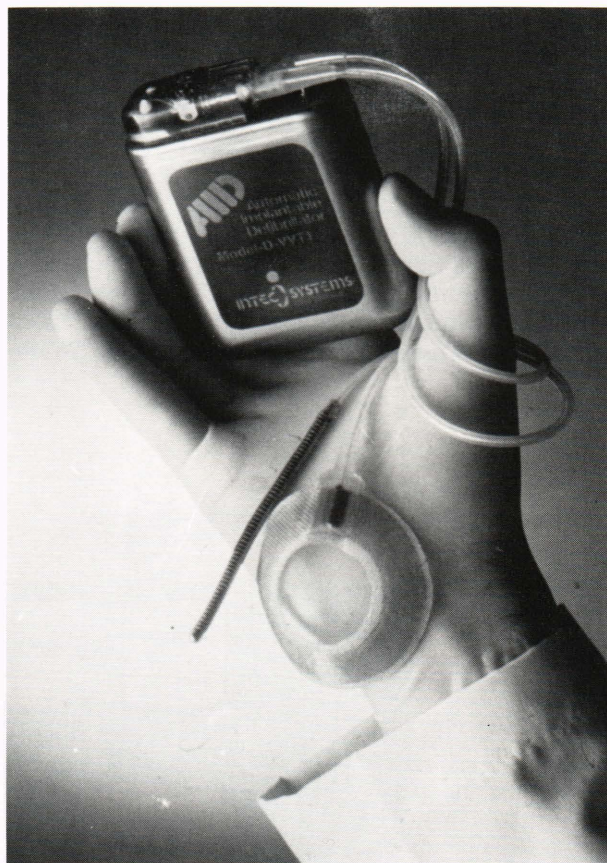

Figure 12. The Automatic Implantable Cardiac Defibrillator with the long, slender lead and cup electrode.

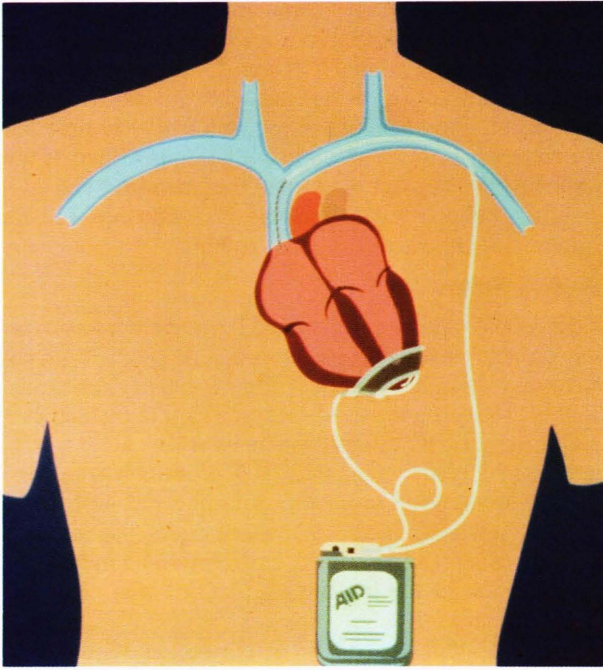

Figure 13. The Automatic Implantable Cardiac Defibrillator with the electrical leads and electrodes in place.

The Role of APL in the AICD Project

Having heard of APL's high-technology capabilities, Dr. Mirowski sought out the Laboratory's assistance in 1974. Among the first improvements in the AICD instigated by APL was the introduction of the same satellite reliability and quality control techniques that had been applied to component selection, fabrication, and test procedures for APL spacecraft. These were the same techniques that had made a success of the rechargeable pacemaker. Furthermore, a system was created by the APL engineers for alerting the patient with a subcutaneous buzzer when an episode of ventricular fibrillation had occurred. Further, APL developed a system for holding in digital form the patient's electrocardiogram (ECG) for 10 s before and 15 s after a fibrillation event. Both features were designed to provide the physician with an improved understanding of how to apply the AICD therapeutically.

To verify how well such an alarm and recording system would work without interfering with progress toward completing an implantable version of the AICD, funding was obtained from NASA to develop an external system capable of recording the ECG both before and after the fibrillation event. Figure 14 shows the recorder as it was worn by an AICD patient. Figure 15 shows the entire recording system, including the recorder, straps for holding the chest electrodes and the recorder, and the console for playing back the recorded data.

The First Implant

The first implant was performed by Johns Hopkins surgeon Dr. Levi Watkins, Jr., on 4 February 1980. The first patient was a 47-year-old woman from San Mateo, California, who had experienced two episodes of ventricular fibrillation but had miraculously survived.

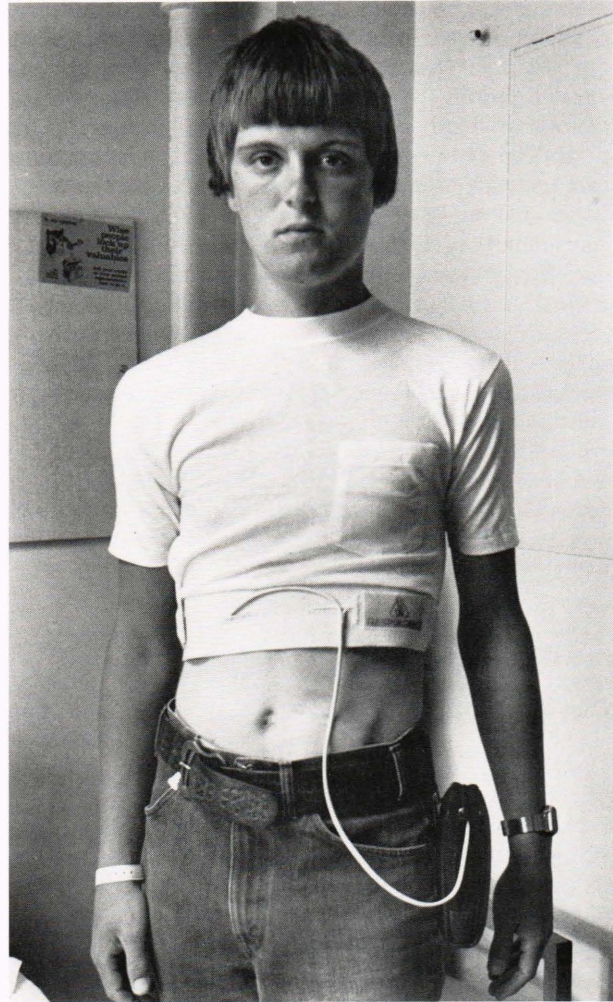

Figure 14. A patient with the recording system for the Automatic Implantable Cardiac Defibrillator in place.



Figure 15. The recording system for the Automatic Implantable Cardiac Defibrillator.

The glass-enclosed gallery above the operating room included many engineers and scientists who had been working on the AICD development for many years. The

APL attendees were surprised to see that the surgery was much more extensive than that for a pacemaker implant. For these first AICD patients, the entire rib cage was opened until the heart lay clearly visible for the surgeon to attach the cup electrode at the bottom (apex) of the heart. The vena cava electrical lead was then carefully inserted into the large vein above the patient's heart. Everything was now ready for placing the AICD device subcutaneously just under the abdominal skin. The surgeon turned away from the operating table and asked the nurse to hand him the AICD, which was contained in a sterilized pouch. Ten people in the operating room and twice that number in the gallery gasped when the nurse opened the pouch and then dropped the AICD on the floor. One thing learned from spacecraft operations was to have spare parts available. In this instance, a second AICD unit had already been placed on the sterile table, and it was taken out of its pouch with great care. Dr. Watkins proceeded calmly to implant it in the patient, connect the leads, and close the incision.

The First Test

Because the AICD had never been tested in a human subject, it was decided to evaluate the device's performance in the first patient under very controlled conditions. These "controlled" conditions really became an extraordinary experiment in the catheterization laboratory. The only way to tell if the AICD functioned properly was to stop the patient's heart from beating by sending a strong electric current through the heart muscle so that the heart would go into ventricular fibrillation. The AICD would then (hopefully) automatically restart the heart. As a backup for the AICD, an external defibrillator was close at hand and ready to go to work. The first test of APL's ECG recording system was to record the entire event.

With the catheterization laboratory filled with a dozen people, Dr. Philip Reid directed the critical first test on 22 February 1980. It took quite a while to drive her heart into the typically fatal rhythm of ventricular fibrillation, during which time the tension rose in the crowded room. Finally, the CRT display showed the classical EGG signal that indicated fibrillation. After ten years of effort, the real moment of truth for the AICD system was at hand. In about 15 s, the AICD was to sense the lethal rhythm and fire a 600-V pulse into the heart. But that did not happen. At 30 s, with no response from the AICD, Dr. Reid started charging the external defibrillator. He placed the paddles on the woman's chest and yelled "stand back"

when, at last, the AICD "automatically" fired. After an 8-s post-shock recorder recovery time, the patient once again displayed a normal ECG signal. Figure 16 is a copy of the actual ECG record made with the APL recording equipment. Only a short portion of the 40 s of time that the patient was in ventricular fibrillation is shown. It was probably the longest 40 s that the attendees had ever endured, but the AICD fired and promptly restored the patient's heartbeat to a normal rhythm.

Present Status

Excellent clinical results have been achieved with the implantable automatic defibrillator. Patients typically have more than doubled their life expectancy if the AICD is used. Today, hundreds of AICD units are implanted each month in patients throughout the world.

One of the two companies now manufacturing these defibrillators, Ventritex, Inc., of Sunnyvale, California, obtained a license under APL's patent for the patient alarm and recording features. These capabilities are included in their version of the implantable defibrillator.

THE PROGRAMMABLE IMPLANTABLE MEDICATION SYSTEM

Creating a Workable Concept

The most recent implantable medical device developed at APL is the Programmable Implantable Medication System (PIMS) (see Fig. 17), the genesis of which is somewhat unusual.

Because the APL biomedical engineers regularly worked with NASA Headquarters and the Goddard Space Flight Center on the transfer of space technology to medicine, meetings were held with these NASA groups. At one such meeting, Raymond Whitten of NASA Headquarters asked if there were any new ideas at APL that warranted NASA sponsorship. When the PIMS concept was presented, NASA decided to support its development at APL and promised (and eventually delivered) several million dollars to support APL's R&D activities. They also suggested that, since the Parker-Hannifin Company had designed much of the fluid-handling systems for the space shuttle, they would have the requisite skill for designing the PIMS fluid handling system including the reservoir, pump, and piping systems. Pacemaker Systems, Inc., having worked with APL on the rechargeable pacemaker, was selected to manufacture the PIMS electronics in production and to market PIMS to the medical community.

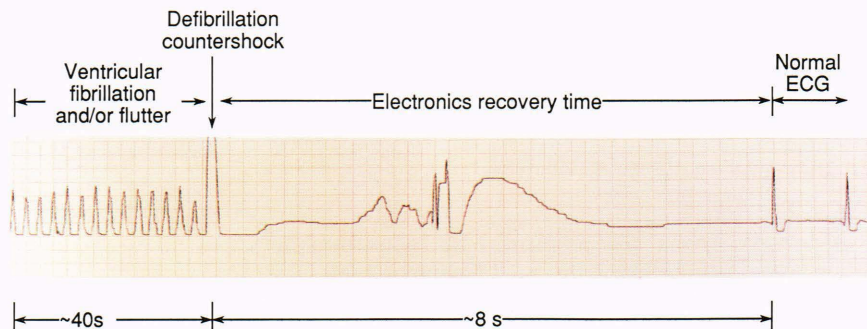

Figure 16. The first use in a human of the Automatic Implantable Cardiac Defibrillator.

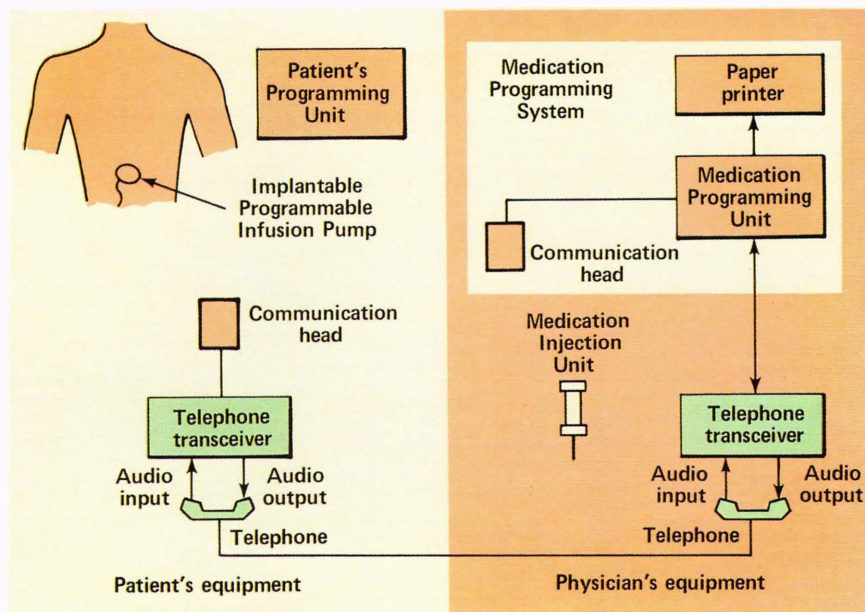

Figure 17. Block diagram of the Programmable Implantable Medication System.

Since the use of external insulin pumps had indicated that the diabetic's blood sugar control was greatly improved with round-the-clock insulin delivery, the first application of PIMS was to provide an improved, implantable source of insulin for the treatment of diabetes.

But what about a supplier for insulin? Most people are aware that insulin is frequently kept in the refrigerator, so a first concern about the insulin for PIMS was its stability at body temperature of 98.6°F (37°C). It was encouraging to discover that insulin was kept in the refrigerator to avoid exposure to direct light such as sunlight. In fact, at body temperature the type of pure, fast-acting insulin that was needed for PIMS lost potency at the rate of only about 1% per month, an insignificant amount because the pump was refilled every three months. It was learned from an insulin pump development group in Toronto, however, that when insulin is shaken, as it would be in the body, within a few hours to a few days it turns into a jelly-like substance that cannot be pumped. The next problem was to develop an insulin that would remain a free-flowing liquid when gently shaken for three months at body temperature.

Since 95% of all insulin sold in America came from the Eli Lilly Company, an executive there was asked to help with the PIMS project, but he declined. Next, the head of special projects at E.R. Squibb & Sons, Inc., which had a small but finite 5% of the U.S. market, was contacted. This individual said that diabetic patients are willing to inject themselves with insulin and therefore would not want to have an implantable pump. Squibb also would not work with APL. Because no other U.S. companies provided insulin, attention was turned to foreign pharmaceutical companies. The world's leading insulin company outside the U.S. was Novo Pharmaceutical in Copenhagen, Denmark.

In early 1980, a meeting at Novo was arranged with their scientists and decision makers to find out if Novo would support the PIMS program by providing a specially

engineered insulin that would not turn into jelly after a few days in an implanted pump. The APL presentation began at about 3:00 PM in a small lecture hall at Novo corporate headquarters in Copenhagen. Surprisingly, the room was filled with about thirty insulin chemists, other scientists, and managers; one might normally expect only three to five people for such a meeting. The key decision maker was the Senior Vice President for Research, a world-famous inventor who had eleven patents on important insulin compounds. He introduced the APL presenter to the assembly and then said that he didn't believe that there was any chance that APL or anyone else would ever be able to make an implantable insulin pump. He did say he would be willing to hear what the PIMS idea was all about. The PIMS concept was then presented using about forty slides. There were extensive discussions and interruptions for questions. The one-hour talk was still going on at 5:15 PM, and only about a half-dozen people remained because 5:00 PM was the normal quitting hour. Still sitting in the front row, however, was the formidable Senior Vice President. When the last slide was shown and the last question was asked and answered, there was a long silence, after which he said, "I was wrong. I believe the PIMS system will work and your laboratory [APL] should be capable of making it work. No one has ever made a motion-resistant insulin, but I believe we can do it and we will do it." Two years later, the leader of Novo's team of six insulin chemists and technicians presented the data to the APL PIMS development team showing that, indeed, they had perfected the special insulin needed for PIMS.

Engineering and Animal Testing

Under NASA sponsorship, a multidisciplinary team was established to design, build, and evaluate the PIMS system. The fluid-handling system was created by the Biomedical Engineering Group of the Parker-Hannifin Corporation. Insulin for PIMS was first provided by Novo Pharmaceuticals and later by Hoechst Pharmaceuticals. A special

lithium thionyl chloride battery that had a five-to-seven-year life was created for PIMS by the Wilson Greatbatch Company. The overall system designs and management, as well as all the electronic systems design, were APL's responsibility. Animal and human trials were accomplished at the Johns Hopkins School of Medicine under the direction of Dr. Chris Saudek.

Figure 18 shows the first laboratory dog used for PIMS evaluation. The diabetic animal had the pump implanted under the skin just behind the shoulder. Although animal-rights advocates might suggest that the PIMS system could have been tested on a computer, only in a living diabetic animal could the safety and efficacy of the PIMS system be proven.

First Human Implantation

On 10 November 1985, the first PIMS insulin pump was implanted under the skin of Dr. Jack Piatrow, a professor



Figure 18. A patient programming unit being used to adjust insulin delivery in a diabetic test animal.

of International Relations at the American University. Dr. Piatrow was called a "brittle" diabetic; that is, his blood sugar was very difficult to control. Dr. Piatrow and the team of APL engineers who created PIMS are shown in Figure 19.

The Treatment of Diabetes with PIMS

By late 1991, several hundred patients at several medical centers in the United States and Europe were having their diabetes controlled by a PIMS implant. Typical results are shown in Figures 20 and 21. Figure 20 shows the mean blood glucose level for the first ten patients who were implanted at The Johns Hopkins Hospital. For diabetic patients, keeping the mean blood glucose under 200 mg/dL is considered good control; mean blood glucose under 150 mg/dL is excellent. Normal individuals typically have a blood glucose level of 100 ± 25 mg/dL.

Figure 21 shows the percent of time that the first ten PIMS patients had a blood glucose level greater than 200 mg/dL. The sharply lower percent of glucose readings greater than 200 mg/dL for PIMS users is clearly seen in the figure.

It should be remembered that the preimplant data were *not* obtained with diabetic patients using one or two injections of insulin each day. Those patients would be the vast majority of all diabetics, and their preimplant data would be much worse than those presented in Figures 20 and 21. Rather, to obtain preimplant data for the PIMS human trials, all patients were placed on external, computer-controlled insulin pumps that are (except for PIMS) the best method for controlling the blood sugar of insulin-dependent diabetics. Because PIMS offered a significant advance over insulin therapy using external insulin pumps, PIMS may be the best possible treatment for many diabetic patients.



Figure 19. Dr. Piatrow and the team of APL engineers who created the Programmable Implantable Medication System (PIMS). Seated, left to right, are Wade Radford, the PIMS program manager; Dr. Piatrow; and the author. Standing, left to right, are Art Hogrefe, creator of the PIMS command and telemetry system; Charles Blackburn, designer of the PIMS implantable computer; Al Sadilek, the mechanical system designer; and Kermit Sanders, who created the external support equipment including the physician's console and much of the PIMS software.

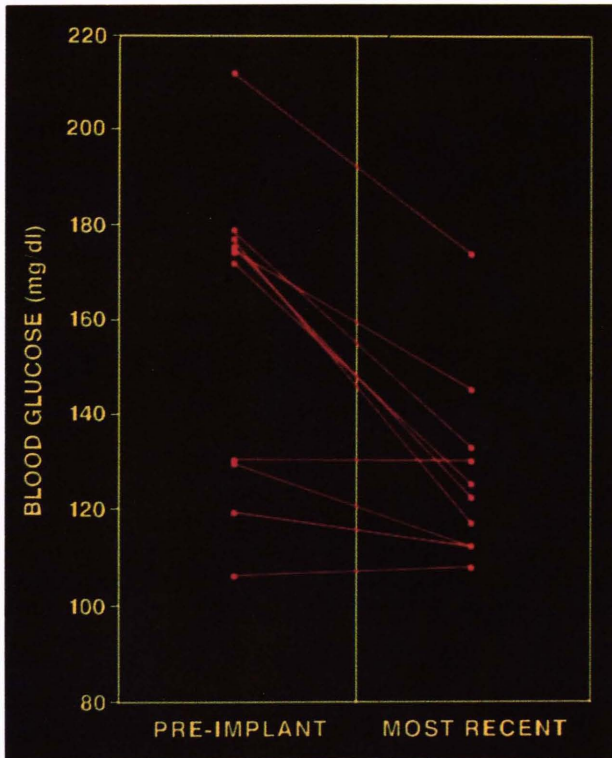

Figure 20. Mean blood glucose results with the Programmable Implantable Medication System (first ten patients).

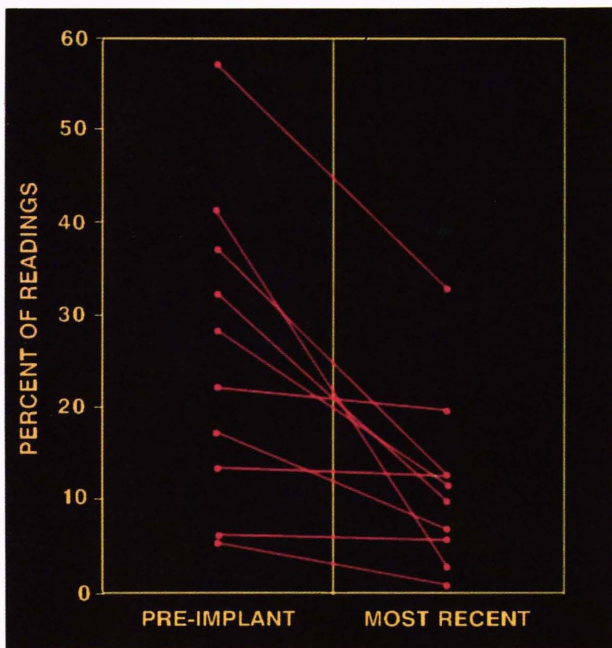

Figure 21. Percent of readings greater than 200 mg/dL (first ten patients).

SUMMARY

Improvements in pacemakers, tissue stimulators, automatic implantable cardiac defibrillators, and implantable insulin pumps are being made by several corporations in the United States and abroad. New uses for PIMS-type devices are being implemented or are in animal trials.

Over the last twenty years of APL's 50-year history, many APL scientists, engineers, technicians, and programmers have worked together to create extraordinary advances in the art and science of implantable medical devices. In the next twenty years and for decades beyond, this innovative technology will be applied for the benefit of many thousands of patients who can benefit from the therapy administered by such implantable devices.

REFERENCES

- ¹Frick, M. H., "Efficiency of a Pacemaker Clinic to Prevent Sudden Pacing Failures," *Brit. Heart J.* **35**, 1280-1284 (1973).
- ²Fischell, R. E., Lewis, K. B., Schulman, J. H., and Love, J. W., "A Long-Lived, Reliable, Rechargeable Cardiac Pacemaker," Chap. 5 in *Advances in Pacemaker Technology*, Scholdach, M., and Furman, S. (eds.), Springer-Verlag, Berlin, Heidelberg, New York, pp. 357-382 (1975).
- ³Fischell, R. E., Schulman, J. H., and Cooper, I. S., "An Intracorporeal System for Cerebellar Stimulation," Chap. 11 in *Cerebellar Stimulation in Man*, Cooper, I. S. (ed.), Raven Press, New York, pp. 195-206 (1978).
- ⁴Mirowski, M., Reid, P. R., Mower, M. M., Watkins, L., Gott, V. L., Schauble, J. F., Langer, A., Heilman, M. S., Kolenik, S. A., Fischell, R. E., and Weisfeldt, M. L., "Termination of Malignant Ventricular Arrhythmias with an Implanted Automatic Defibrillator in Human Beings," *N. Engl. J. Med.* **303**, 322-324 (1980).

THE AUTHOR



ROBERT E. FISCHELL was born in New York City in 1929. He was graduated from Duke University in 1951 with a B.S.M.E. degree and from the University of Maryland in 1953 with an M.S. degree in physics. He joined APL's Space Department in 1959, where he was a project supervisor and later a group supervisor for space power systems and attitude control systems. In 1980, Mr. Fischell became the first Chief Engineer of the Space Department and later became Assistant Space Department Head. In 1979, he became interested in the application of space technology for implantable medical devices. In 1983, he became Chief of Technology Transfer in the Space Department. Since 1989, Mr. Fischell has retained a part-time position at APL to continue his work on implantable devices. Most of his time is now spent working in collaboration with his sons in the development of catheters for opening clogged arteries in human coronary and peripheral arteries. Mr. Fischell has more than fifty issued U.S. patents, mostly in the field of medical devices. In 1990, Mr. Fischell became the first APL staff member to be elected to the National Academy of Engineering.